



**Art.Nr.: 74000406 - Kunststofffelge
schmale Version verchromt**

Zur Montage an den ScaleDRIVE Vorderachsen
Art.Nr.: 71000315 und 74000401 sowie der ScaleDRIVE
Hinterachse Art.Nr.: 74000400
- 2 Felgen aus Kunststoff galvanisch verchromt
- passend für Lkw Modelle im Maßstab 1:14 (Tamiya®)



www.SCALEDRIVE.de



ScaleART OHG - Schillerstraße 3-7 - D67165 Waldsee
Tel.: +49 (0) 6236-416651 - Mail: info@scaleart.de

Die folgenden Reifentypen können mit den Felgen verwendet werden:

- Tamiya®:
Art.Nr.: 300056527 Truckreifen
Carson®:
Art.Nr.: 500907011 Fulda Geländereifen "Crossforce"
Art.Nr.: 500907014 Fulda EcoControl Antriebsreifen

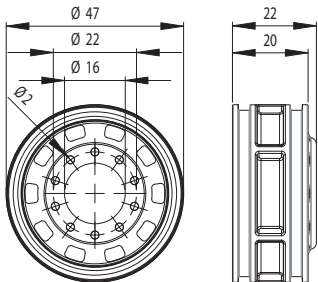

01 Felge schmal verchromt 2 11000053

Dieses Modell ist kein Spielzeug und für Jugendliche unter 14 Jahren nicht geeignet. Jegliche technische Änderung und Modifikation behalten wir uns vor. Für Irrtümer und Druckfehler übernehmen wir keine Haftung. Nachdruck und Vervielfältigung sind nur mit unserer ausdrücklichen, schriftlichen Genehmigung gestattet.

Tamiya und Carson sind eingetragene Marken der
DICKIE-TAMIYA Modellbau GmbH & Co.KG

Montage an einer ScaleDRIVE Hinterachse

Art.Nr.: 74000400

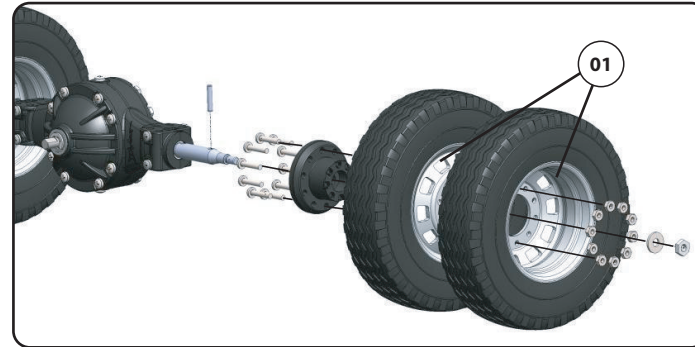

Montage an einer ScaleDRIVE angetriebenen Vorderachse

Art.Nr.: 74000401

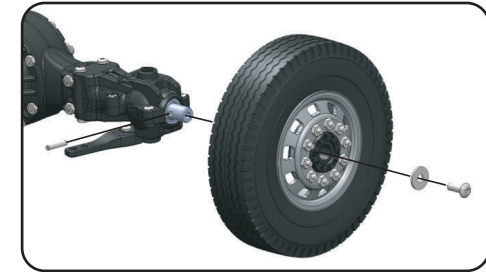
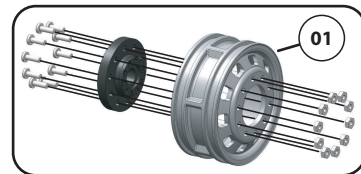

Montage an einer ScaleDRIVE Vorderachse

Art.Nr.: 71000315

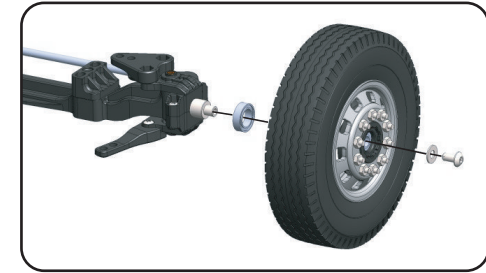
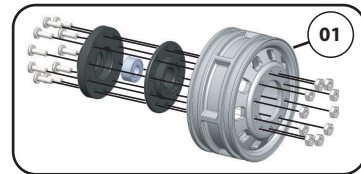

Montage an einer Tamiya® Vorderachse

Zusätzlich benötigt:
Radnabe für Tamiya Vorderachse

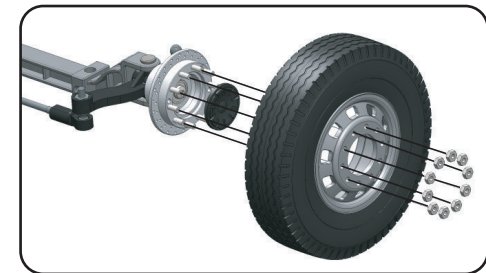
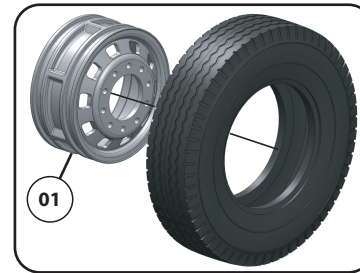
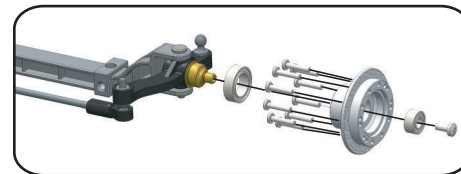

Montage an einer Tamiya® Hinterachse

Zusätzlich benötigt:
Radnabe für Tamiya Antriebsachse
ScaleDRIVE Art.Nr.: 7400079

Version 1 mit Kunststoffradnabe Art.Nr.: 74000078
Version 2 mit Aluminiumradnabe Art.Nr.: 74000080
Dargestellt ist die Version 2 in Aluminium.



Item nr.: 74000406 - plastic rims narrow version chromed

For assembling to a ScaleDRIVE front-axe
 Item nr.: 71000315 and 74000401 and to a ScaleDRIVE rear-axe item nr.: 74000400
 - 2 rims made of plastic galvanized, chromed
 - suitable for truck-models in scale 1:14 (Tamiya®)



www.SCALEDRIVE.de



ScaleART OHG - Schillerstraße 3-7 - D67165 Waldsee
 Tel.: +49 (0) 6236-416651 - Mail: info@scaleart.de

The following types of tires can be used with the rims:
 Tamiya®:
 Item nr.: 300056527 truck-tires
 Carson®:
 Item nr.: 500907011 Fulda off-road tires "Crossforce"
 Item nr.: 500907014 Fulda EcoControl drive tires

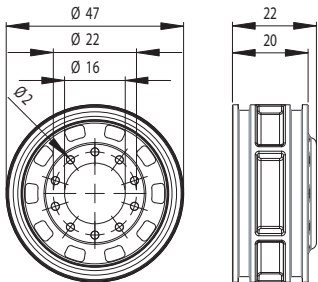

01 narrow chromed rim 2 11000053

Assembling to a ScaleDRIVE rear-axe

Item nr.: 74000400

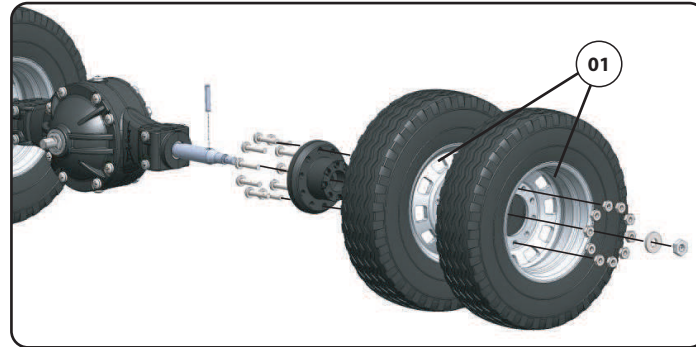

Assembling to a Tamiya® rear-axe

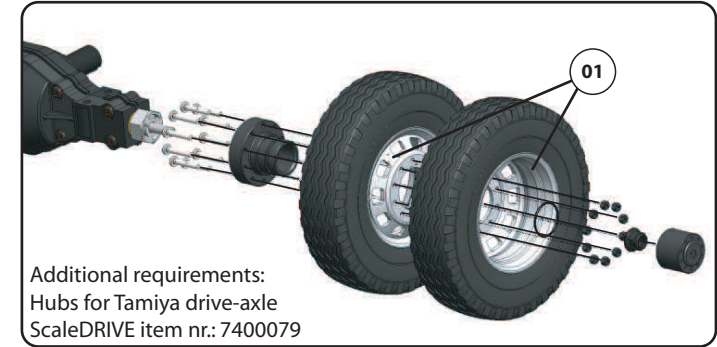

Assembling to a ScaleDRIVE driven front-axe

Item nr.: 74000401

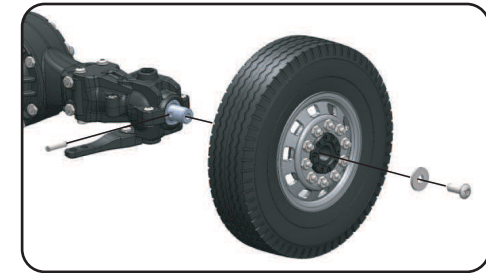
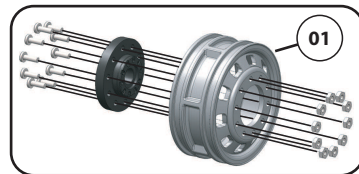

Assembling to a ScaleDRIVE non driven front-axe

Art.Nr.: 71000315

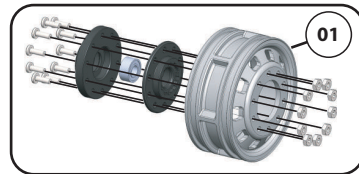

Assembling to a Tamiya® front axle

Additional requirement:
 Hubs for Tamiya front-axe

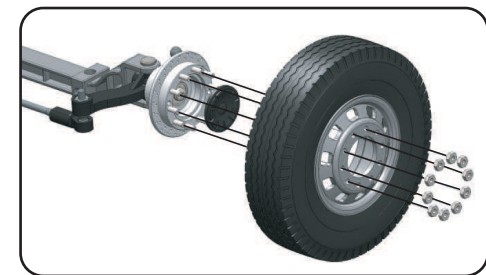
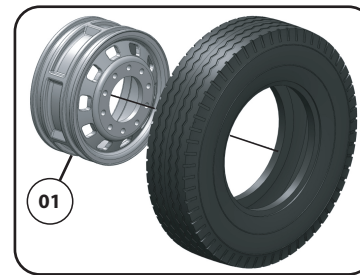
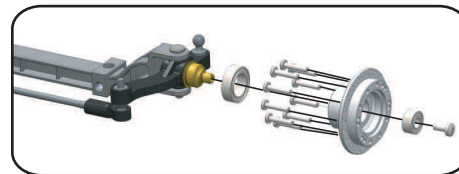

Version 1 with pastic hubs item nr.: 74000078
 Version 2 aluminium hubs item nr.: 74000080
 Displayed: Version 2 in aluminium.